

TVS Diodes

Transient Voltage Suppression Diodes

SMCJ Series



Description

Transient Voltage Suppressor (TVS) is a circuit protection component that either attenuates (reduces) or filters a transient voltage spike (overvoltage), TVS diodes provide critical protection by going into avalanche breakdown within no more than a few nanoseconds after a strike, clamping the transient voltage, and routing its current to the ground.

Applications

- Communication Equipment
- Security & Protection
- Industrial Control Equipment
- Power Supply
- Automotive Electronics
- New Energy
- Surge Protection

Functional Diagram



Uni-Directional



Bi-Directional

Features

- Low incremental surge resistance
- Excellent clamping capability
- Low profile package with built-in strain relief
- Typical I_R less than 1.0 μA above 12 V
- 1500 W peak pulse power capability with a 10/1000 μs Waveform, repetition rate (duty cycle): 0.01%
- For surface mounted applications to optimize board space
- Typical failure mode is short from over-specified voltage or current
- IEC 61000-4-2 ESD 30 kV (Air), 30 kV (Contact)
- EFT protection of data lines in accordance with IEC 61000-4-4
- Very fast response time
- Glass passivated chip junction
- High temperature to reflow soldering guaranteed: 260 $^{\circ}C/30sec$
- $V_{BR} @ T_J = V_{BR@25^{\circ}C} \times (1 + \alpha T \times (T_J - 25))$
(αT : Temperature Coefficient, typical value is 0.1%)
- Plastic package is flammability rated V-0 per Underwriters Laboratories
- Meet MSL level1, per J-STD-020
- Matte tin lead-free plated
- Halogen free and RoHS compliant
- Pb-free E3 means 2nd level interconnect is Pb-free and the terminal finish material is tin(Sn) (IPC/JEDEC J-STD-609A.01)

TVS Diodes

Transient Voltage Suppression Diodes

SMCJ Series

Package Outline Dimensions (DO-214AB)

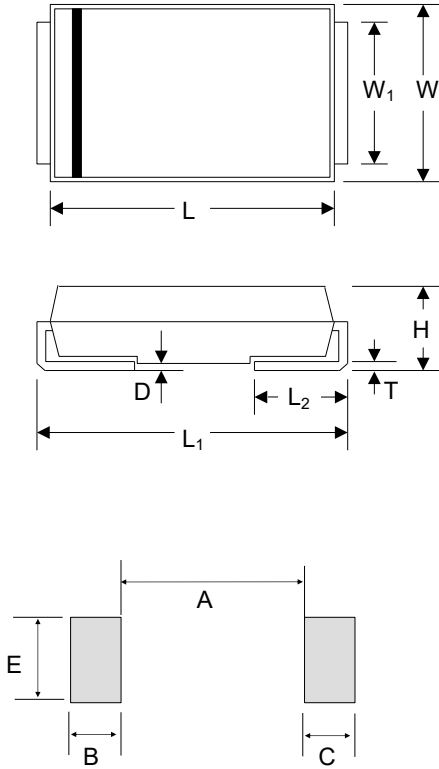

Mounting Pad Layout

Symbol	Millimeters		Inches	
	Min.	Max.	Min.	Max.
L	6.60	7.11	0.260	0.280
W	5.59	6.22	0.220	0.245
W ₁	2.90	3.20	0.114	0.126
H	2.06	2.62	0.079	0.103
T	0.152	0.305	0.006	0.012
L ₁	7.75	8.13	0.305	0.320
L ₂	0.76	1.52	0.030	0.060
D	-	0.203	-	0.008
A	-	4.20	-	0.165
B	2.40	-	0.094	-
C	2.40	-	0.094	-
E	3.30	-	0.129	-

Maximum Ratings and Characteristics

(Ratings at 25 °C ambient temperature unless otherwise specified.)

Parameter	Symbol	Value	Unit
Peak Pulse Power Dissipation(Fig.2) by 10/1000 us Test Waveform ⁽¹⁾⁽²⁾ (Fig.4) -Single Die Parts	P _{PPM}	1500	W
Peak Pulse Power Dissipation(Fig.2) by 10/1000 us Test Waveform ⁽¹⁾⁽²⁾ (Fig.4) - Stacked Die Parts ⁽⁵⁾	P _{PPM}	2000	W
Peak Power Dissipation on Infinite Heat Sink at T _L =50 °C	P _D	6.5	W
Peak Forward Surge Current,8.3 ms single half sinewave superimposed on rated load (JEDEC Method) ⁽³⁾	I _{FSM}	200	A
Maximum Instantaneous Forward Voltage at 100 A for Unidirectional Only ⁽⁴⁾	V _F	3.5/5.0	V
Operating Junction and Storage Temperature Range	T _J ,T _{STG}	-55 to +150	°C
Typical Thermal Resistance Junction to Lead	R _{θJL}	15	°C / W
Typical Thermal Resistance Junction to Ambient	R _{θJA}	75	°C / W

Notes

1. Non-repetitive current pulse, per Fig. 4 and derated above T_J(initial)=25 °C per Fig. 3.
2. Mounted on 8.0 mm² land areas.
3. Measured of 8.3 ms single half sine-wave or equivalent square wave, duty cycle=4 pulses per minute maximum.
4. V_F < 3.5 V for single die parts and V_F < 5.0 V for stacked-die parts.
5. For stacked die component details, please refer to part numbers labeled by * in Electrical Characteristics.

TVS Diodes

Transient Voltage Suppression Diodes

SMCJ Series

Part Numbering System

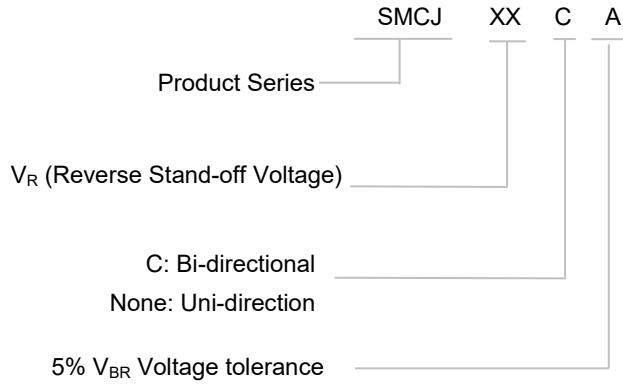

Marking

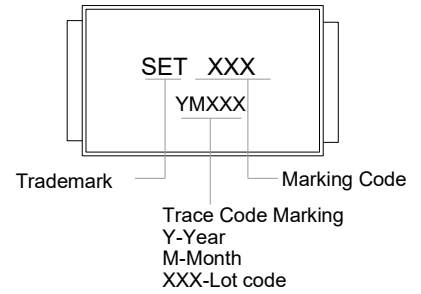
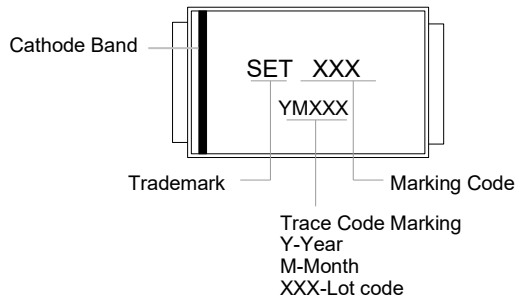

TVS Diodes

Transient Voltage Suppression Diodes

SMCJ Series

Electrical Characteristics (T_A=25 °C unless otherwise noted)

Part Number		Device Marking Code		Breakdown Voltage V _{BR} @I _T		Test Current I _T	Reverse Stand-off Voltage V _R	Max. Reverse Leakage I _R @V _R	Max. Peak Pulse Current I _{PPM}	Max. Clamping Voltage V _C @I _{PPM}
				Min	Max					
Uni	Bi	Uni	Bi	(V)		(mA)	(V)	(μA)	(A)	(V)
SMCJ5.0A	SMCJ5.0CA	GDE	BDE	6.40	7.00	10	5.00	600.00	163.00	9.20
SMCJ6.0A	SMCJ6.0CA	GDG	BDG	6.67	7.37	10	6.00	500.00	145.70	10.30
SMCJ6.5A	SMCJ6.5CA	GDK	BDK	7.22	7.98	10	6.50	300.00	134.00	11.20
SMCJ7.0A	SMCJ7.0CA	GDM	BDM	7.78	8.60	10	7.00	200.00	125.00	12.00
SMCJ7.5A	SMCJ7.5CA	GDP	BDP	8.33	9.21	1	7.50	100.00	116.30	12.90
SMCJ8.0A	SMCJ8.0CA	GDR	BDR	8.89	9.83	1	8.00	50.00	110.30	13.60
SMCJ8.5A	SMCJ8.5CA	GDT	BDT	9.44	10.40	1	8.50	20.00	104.20	14.40
SMCJ9.0A	SMCJ9.0CA	GDV	BDV	10.00	11.10	1	9.00	10.00	97.40	15.40
SMCJ10A	SMCJ10CA	GDX	BDX	11.10	12.30	1	10.00	5.00	88.30	17.00
SMCJ11A	SMCJ11CA	GDZ	BDZ	12.20	13.50	1	11.00	1.00	82.50	18.20
SMCJ12A	SMCJ12CA	GEE	BEE	13.30	14.70	1	12.00	1.00	75.40	19.90
SMCJ13A	SMCJ13CA	GEG	BEG	14.40	15.90	1	13.00	1.00	69.80	21.50
SMCJ14A	SMCJ14CA	GEK	BEK	15.60	17.20	1	14.00	1.00	64.70	23.20
SMCJ15A	SMCJ15CA	GEM	BEM	16.70	18.50	1	15.00	1.00	61.50	24.40
SMCJ16A	SMCJ16CA	GEP	BEP	17.80	19.70	1	16.00	1.00	57.70	26.00
SMCJ17A	SMCJ17CA	GER	BER	18.90	20.90	1	17.00	1.00	54.40	27.60
SMCJ18A	SMCJ18CA	GET	BET	20.00	22.10	1	18.00	1.00	51.40	29.20
SMCJ20A	SMCJ20CA	GEV	BEV	22.20	24.50	1	20.00	1.00	46.30	32.40
SMCJ22A	SMCJ22CA	GEX	BEX	24.40	26.90	1	22.00	1.00	42.30	35.50
SMCJ24A	SMCJ24CA	GEZ	BEZ	26.70	29.50	1	24.00	1.00	38.60	38.90
SMCJ26A	SMCJ26CA	GFE	BFE	28.90	31.90	1	26.00	1.00	35.70	42.10
SMCJ28A	SMCJ28CA	GFG	BFG	31.10	34.40	1	28.00	1.00	33.10	45.40
SMCJ30A	SMCJ30CA	GFK	BFK	33.30	36.80	1	30.00	1.00	31.00	48.40
SMCJ33A	SMCJ33CA	GFM	BFM	36.70	40.60	1	33.00	1.00	28.20	53.30
SMCJ36A	SMCJ36CA	GFP	BFP	40.00	44.20	1	36.00	1.00	25.90	58.10
SMCJ40A	SMCJ40CA	GFR	BFR	44.40	49.10	1	40.00	1.00	23.30	64.50
SMCJ43A	SMCJ43CA	GFT	BFT	47.80	52.80	1	43.00	1.00	21.70	69.40
SMCJ45A	SMCJ45CA	GFV	BFV	50.00	55.30	1	45.00	1.00	20.60	72.70
SMCJ48A	SMCJ48CA	GFX	BFX	53.30	58.90	1	48.00	1.00	19.40	77.40

TVS Diodes

Transient Voltage Suppression Diodes

SMCJ Series

Part Number		Device Marking Code		Breakdown Voltage $V_{BR}@I_T$		Test Current I_T	Reverse Stand-off Voltage V_R	Max. Reverse Leakage $I_R@V_R$	Max. Peak Pulse Current I_{PPM}	Max. Clamping Voltage $V_C@I_{PPM}$
				Min	Max					
Uni	Bi	Uni	Bi	(V)		(mA)	(V)	(μ A)	(A)	(V)
SMCJ51A	SMCJ51CA	GFZ	BFZ	56.70	62.70	1	51.00	1.00	18.20	82.40
SMCJ54A	SMCJ54CA	GGE	BGE	60.00	66.30	1	54.00	1.00	17.30	87.10
SMCJ58A	SMCJ58CA	GGG	BGG	64.40	71.20	1	58.00	1.00	16.10	93.60
SMCJ60A	SMCJ60CA	GGK	BGK	66.70	73.70	1	60.00	1.00	15.50	96.80
SMCJ64A	SMCJ64CA	GGM	BGM	71.10	78.60	1	64.00	1.00	14.60	103.00
SMCJ70A	SMCJ70CA	GGP	BGP	77.80	86.00	1	70.00	1.00	13.30	113.00
SMCJ75A	SMCJ75CA	GGR	BGR	83.30	92.10	1	75.00	1.00	12.40	121.00
SMCJ78A	SMCJ78CA	GGT	BGT	86.70	95.80	1	78.00	1.00	11.90	126.00
SMCJ85A	SMCJ85CA	GGV	BGV	94.40	104.00	1	85.00	1.00	11.00	137.00
SMCJ90A	SMCJ90CA	GGX	BGX	100.00	111.00	1	90.00	1.00	10.30	146.00
SMCJ100A	SMCJ100CA	GGZ	BGZ	111.00	123.00	1	100.00	1.00	9.30	162.00
SMCJ110A	SMCJ110CA	GHE	BHE	122.00	135.00	1	110.00	1.00	8.50	177.00
SMCJ120A	SMCJ120CA	GHG	BHG	133.00	147.00	1	120.00	1.00	7.80	193.00
SMCJ130A	SMCJ130CA	GHK	BHK	144.00	159.00	1	130.00	1.00	7.20	209.00
SMCJ150A	SMCJ150CA	GHM	BHM	167.00	185.00	1	150.00	1.00	6.20	243.00
SMCJ160A	SMCJ160CA	GHP	BHP	178.00	197.00	1	160.00	1.00	5.80	259.00
SMCJ170A	SMCJ170CA	GHR	BHR	189.00	209.00	1	170.00	1.00	5.50	275.00
SMCJ180A	SMCJ180CA	GHT	BHT	201.00	222.00	1	180.00	1.00	5.10	292.00
SMCJ200A	SMCJ200CA	GHV	BHV	224.00	247.00	1	200.00	1.00	4.60	324.00
SMCJ220A	SMCJ220CA	GHX	BHX	246.00	272.00	1	220.00	1.00	4.20	356.00
SMCJ250A	SMCJ250CA	GHZ	BHZ	279.00	309.00	1	250.00	1.00	3.70	405.00
SMCJ300A*	SMCJ300CA*	GJE	BJE	335.00	371.00	1	300.00	1.00	3.10	486.00
SMCJ350A*	SMCJ350CA*	GJG	BJG	391.00	432.00	1	350.00	1.00	2.60	567.00
SMCJ400A*	SMCJ400CA*	GJK	BJK	447.00	494.00	1	400.00	1.00	2.30	648.00
SMCJ440A*	SMCJ440CA*	GJM	BJM	492.00	543.00	1	440.00	1.00	2.10	713.00

Notes:

- For bidirectional type having V_{BR} of 10 volts and less, the I_R should be doubled.
- For parts without A in the PN, the V_{BR} tolerance is $\pm 10\%$ and V_C is 5% higher than parts with A. The parts without A are currently available, but not recommended for new designs. The parts with A are preferred.
- For stacked die component details, please refer to models marked with * in electrical characteristics table.

TVS Diodes

Transient Voltage Suppression Diodes

SMCJ Series

I-V Curve Characteristics

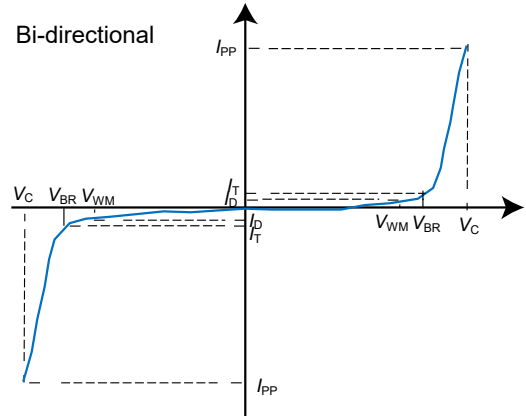
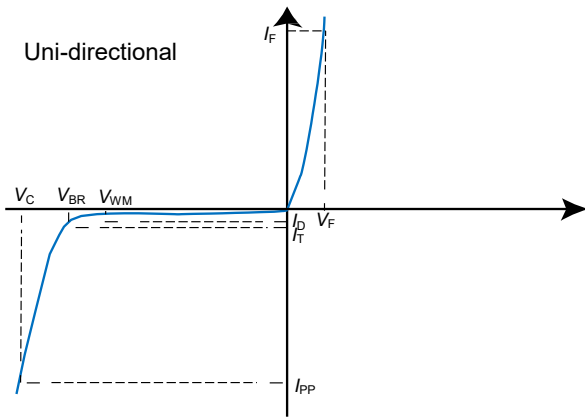

Performance Curve for Reference ($T_A=25^\circ\text{C}$ unless otherwise noted)

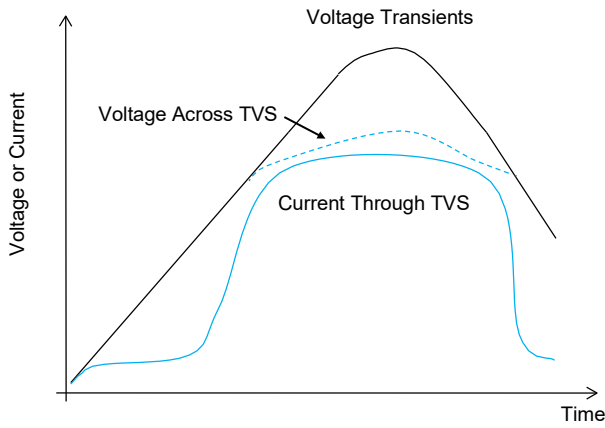

FIGURE 1 TVS Transients Clamping Waveform

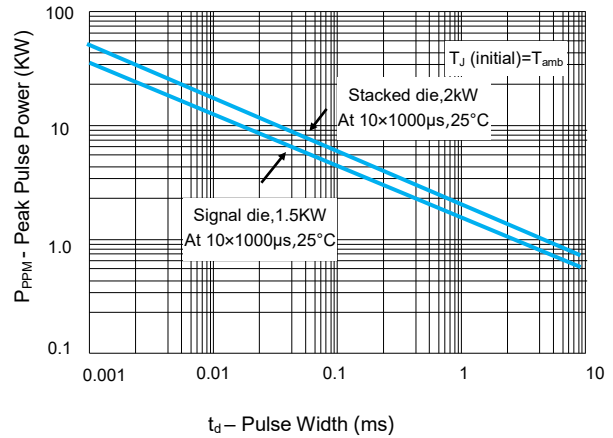

FIGURE 2 Peak Pulse Power Rating Curve

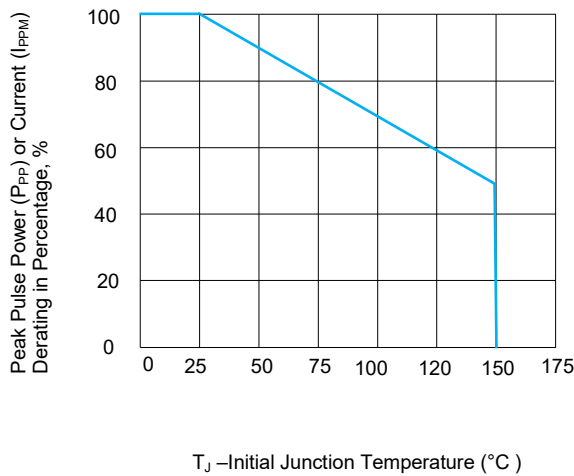

FIGURE 3 Peak Pulse Power Derating Curve

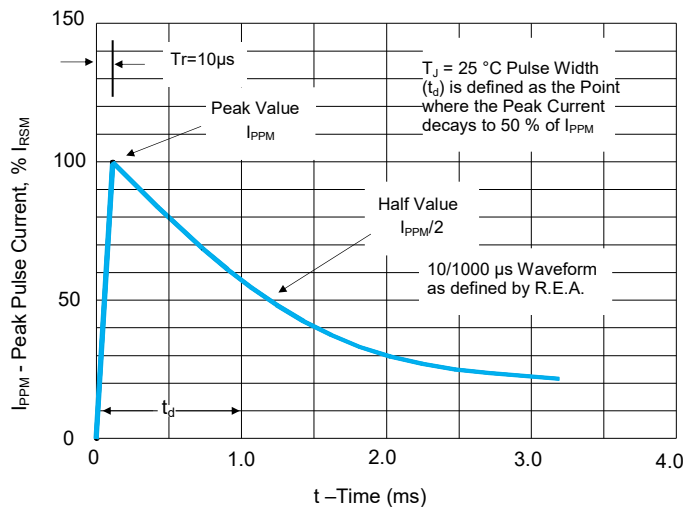

FIGURE 4 Pulse Waveform

TVS Diodes

Transient Voltage Suppression Diodes

SMCJ Series

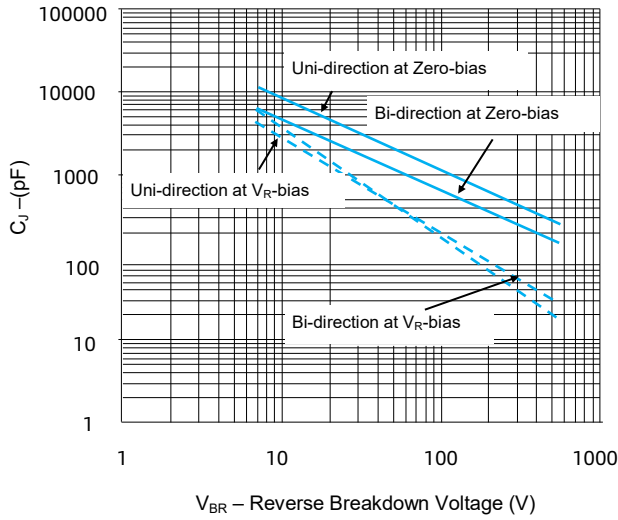

FIGURE 5 Typical Junction Capacitance

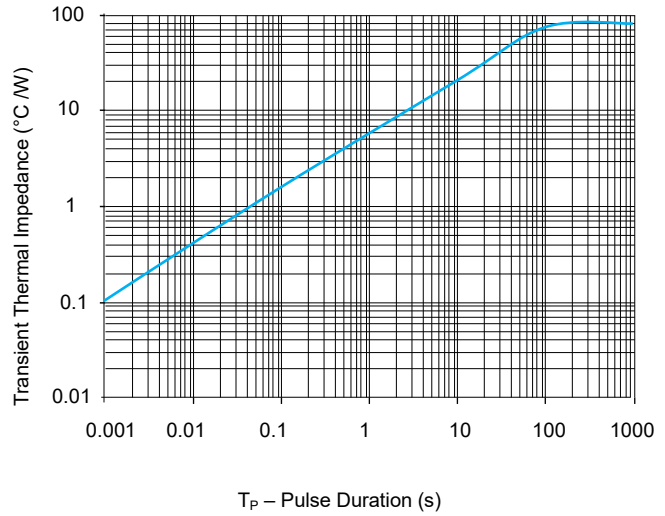

FIGURE 6 Typical Transient Thermal Impedance

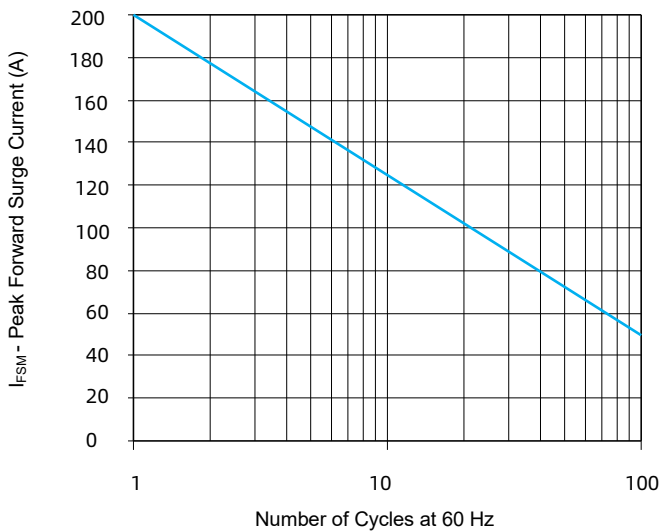

FIGURE 7 Maximum Non-Repetitive Forward Surge Current Uni-Directional only

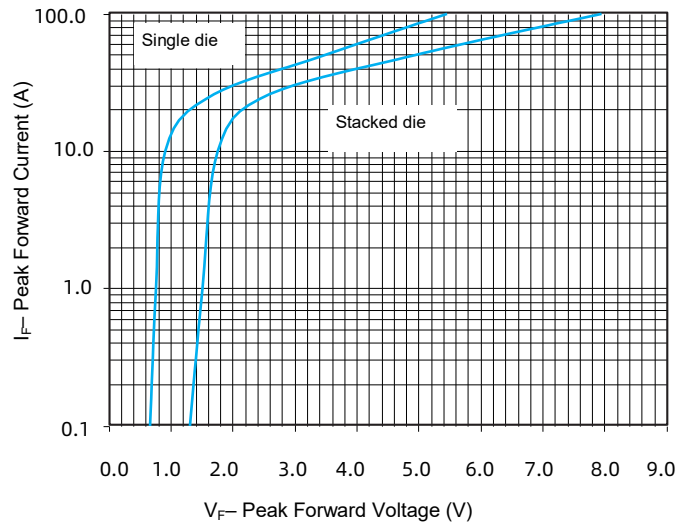

FIGURE 8 Peak Forward Drop vs Peak Forward Current (Typical Values)

Environmental Specifications

High Temp. Storage	JESD22-A103
HTRB	JESD22-A108
MSL	JESDEC-J-STD-020, Level 1
Temperature Cycling	JESD22-A104
H3TRB	JESD22-A101
RSH	JESD22-A111

Physical Specifications

Weight	0.007 ounce, 0.21 grams
Case	JESD22DO214AB. Molded plastic body over glass passivated junction
Polarity	Color band denotes positive end (cathode) except Bidirectional
Terminal	Matte Tin-plated leads, Solderability per JESD22-B102

Soldering Parameters

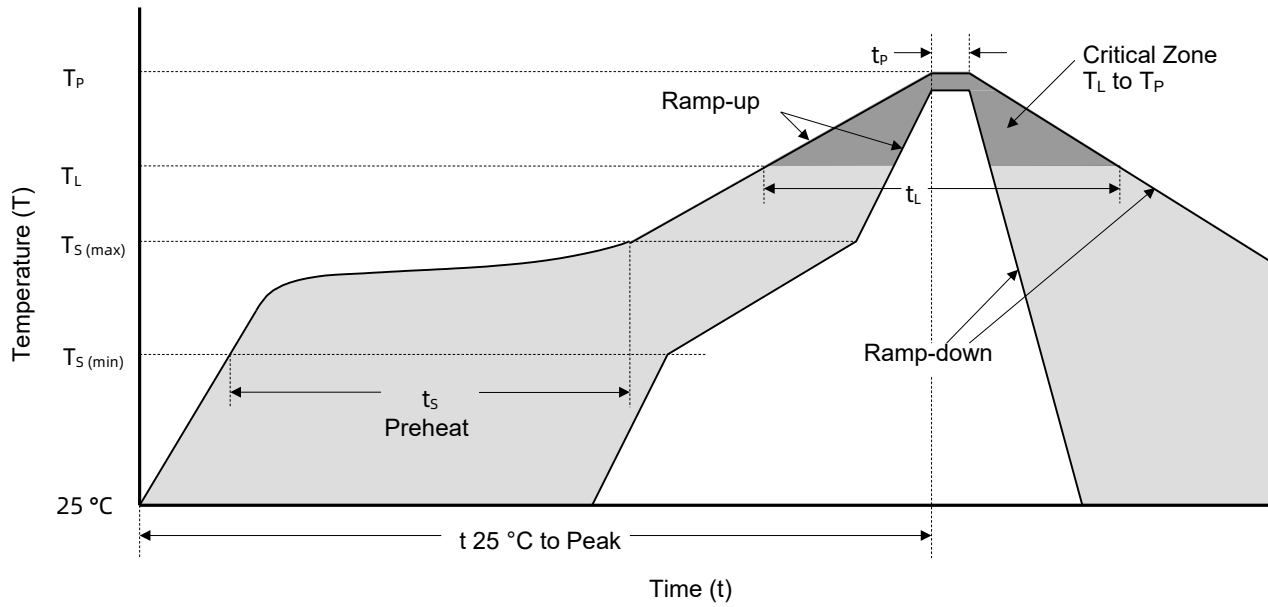

Reflowing Condition

Reflow Soldering Parameters		Lead-Free Assembly
Pre-heat	Temperature Min ($T_{S(min)}$)	150 °C
	Temperature Max ($T_{S(max)}$)	200 °C
	Time (min to max) (t_s)	60 ~ 120 seconds
Average Ramp Up Rate (Liquidus Temp (T_L) to Peak)		3 °C / second max.
$T_{S(max)}$ to T_L Ramp-up Rate		3 °C / second max.
Reflow	Temperature (T_L) (Liquidus)	217 °C
	Time (min to max) (t_L)	60 ~ 150 seconds
Peak Temperature (T_P)		260 ^{+0/-5} °C
Time of within 5 °C of Actual Peak Temperature (t_p)		20 ~ 40 seconds
Ramp-down Rate		6 °C / second max.
Time from 25 °C to Peak Temperature		8 Minutes max.
Do Not Exceed		260 °C

TVS Diodes

Transient Voltage Suppression Diodes

SMCJ Series

Packaging Information

Tape	Symbol	Dimension (mm)
	W	16.00 + 0.3 / - 0.10
	P ₀	4.00 ± 0.10
	P ₁	8.00 ± 0.10
	P ₂	2.00 ± 0.10
	D ₀	1.55 ± 0.05
	D ₁	1.55 ± 0.05
	E	1.75 ± 0.10
	F	7.50 ± 0.10
	A ₀	6.15 ± 0.10
	B ₀	8.30 ± 0.10
	K ₀	2.48 ± 0.10
	T	0.30 ± 0.05

Reel Size	13" Reel	
	A	330 mm
	C	13.2 mm
	W ₁	16.4 mm

Part Number	Package	QTY (Reel)	Packaging Option	Packaging Specification
SMCJxxx	DO-214AB	3000 PCS	Tape & Reel – 16 mm tape/13" reel	EIA STD RS-481

Glossary

Item	Description
V_C	Clamping Voltage Voltage across TVS in a region of low differential resistance that serves to limit the voltage across the device terminals.
V_R	Reverse Stand-off Voltage Maximum voltage that can be applied to the TVS without operation. NOTE : It is also shown as V_{WM} (maximum working voltage (maximum d.c. voltage)) and known as rated stand-off voltage (V_{so}).
I_R	Reverse Leakage Current Current measured at V_R . NOTE : Also shown as I_D for stand-by current.
V_{BR}	Breakdown Voltage Voltage across TVS at a specified current I_T in the breakdown region.
I_{PPM}	Rated Random Recurring Peak Impulse Current Maximum-rated value of random recurring peak impulse current that may be applied to a device.
$P_{M(AV)}$	Rated Average Power Dissipation Maximum-rated value of power dissipation resulting from all sources, including transients and standby current, averaged over a short period of time.
P_{PPM}	Rated Random Recurring Peak Impulse Power Dissipation Maximum-rated value of the product of rated random recurring peak impulse current (I_{PPM}) multiplies by specified maximum clamping voltage (V_C).
C_J	Capacitance Capacitance across the TVS measured at a specified frequency and voltage.
V_{FS}	Peak Forward Surge Voltage Peak voltage across an TVS for a specified forward surge current (I_{FS}) and time duration. NOTE : Also shown as V_F .
I_{FS}	Forward Surge Current Pulsed current through TVS in the forward conducting region. NOTE : Also shown as I_F .
$\alpha_{V(BR)}$	Temperature Coefficient of Breakdown Voltage The change of breakdown voltage divided by the change of temperature.
I_{PP}	Peak pulse Current Peak pulse current value applied across the TVS to determine the clamping voltage V_C for a specified wave shape.
I_T	Pulsed D.C. Test Current Test current for measurement of the breakdown voltage V_{BR} . This is defined by the manufacturer and usually given in milliamperes with a pulse duration of less than 40 ms. NOTE : Also shown as I_{BR} .

—(GB-T 18802.321 / IEC 61643-321 / JESD210A)



ATTENTION

Usage

1. TVS must be operated in the specified ambient temp.
2. Do not clean the TVS with strong polar solvent such as ketone, esters, benzene and halogenated hydrocarbon, to avoid damaging the encapsulating layer.
3. Please do not apply severe vibration, shock or pressure to TVS, to avoid element cracking.

Replacement

1. If TVS is visually damaged, please replace it.
2. TVS is a non-repairable product. For safety sake, please use equivalent TVS for replacement.

Storage

1. Storage Temp. Range: (-55 to 150) °C.
2. Do not store the TVS at the high temp., high humidity or corrosive gas environment, to avoid influencing the solder- ability of the lead wires. The product shall be used up within 1 year after receiving the goods.

Environmental Conditions

1. TVS should not be exposed to the open air, nor direct sunshine.
2. TVS should avoid rain, water vapor or other condition of high temp. and high humidity.
3. TVS should avoid sand dust, salt mist, or other harmful gases.

Max. Typical Capacitance of TVS

The typical capacitance of TVS is listed in the specifications. Designers may refer to it when designing TVS in High frequency circuit.

Installation Mechanical Stress

1. Do not knock TVS when installing, to avoid mechanical damage.
2. Please do not apply severe vibration, shock or pressure to TVS, to avoid surface resin or element cracking.